

FLOOD COB SERIES LED 150W / 18,283 LM FIXTURE

The **FLOOD COB SERIES LED 150W FIXTURE** achieves **18,283 LUMENS**. Featuring a high pressure, die cast aluminum housing with anti-static powder coat finish, this fixture will continue producing high output LED light and looking great through years of extreme outdoor conditions.

Utilizing chip on board (COB) technology, multiple LED chips are bonded directly to the substrate to form a single module. This packaging takes less space and obtains the full potential of the LED chips.

APPLICATION

This outdoor fixture offers general and security lighting for parking areas and garages, building exteriors and facades, public area, and signage applications.

FEATURES & BENEFITS

- 10-year Limited Warranty
- Performance-engineered, clear optical lens assembly delivers unique beam angles and reduces glare
- Highly efficient COB LED technology means longer lasting, brighter light
- Enhanced heat sink design provides improved thermal management

LED & OPTICAL ASSEMBLY

- Translucent, prismatic glass lens
- 120° Type III Light Distribution
- LM-79 tests to IESNA standards

APPROVALS / LISTINGS

- DLC Listed
- ETL Listed to UL1598
- IP65 Rated
- Temperature rated -40°C to 40°C (-40°F to 104°F)

MATERIALS

- Diecast aluminum
- Anti-static powder coat finish

SIZE / WEIGHT (PACKAGED)

9.5" x 13.8" x 12.6" (12.0" x 16.0" x 16.0")
 21 lbs. (23 lbs.)

MOUNTING HARDWARE

Knuckle slipfitter (standard) or adjustable u-bracket (optional).



ORDER INFORMATION

e.g., EL-LED-FLC-150-UL-50

SERIES	WATTAGE	VOLTAGE	COLOR TEMP	OPTIONS
EL-LED-FLC	150			
EL-LED-FLC EVERLAST LED FLOOD COB SERIES	150 WATT 18,283 LUMENS	UL UNIVERSAL (120-277V AC)	50 5000K 75+CRI 40 4000K 75+CRI	AUB ADJUSTABLE U-BRACKET BTN1 120V BUTTON PHOTOCELL BTN2 208-277V BUTTON PHOTOCELL

FLOOD COB SERIES LED 150W / 18,283 LM FIXTURE

EMITTER & DRIVER SPECIFICATIONS

SYSTEM WATTS (120-277V AC)	INITIAL DELIVERED LUMENS (5000K) 75+ CRI	NUMBER OF LEDS	TOTAL CURRENT / FIXTURE			
			120V AC	208V AC	240V AC	277V AC
150	18,283	3 COB	0.80	0.72	0.63	0.54

INPUT

VOLTAGE RANGE	FREQUENCY RANGE	POWER FACTOR	TOTAL HARMONIC DISTORTION	EFFICIENCY (230V AC / 277V AC)
100-277V AC	50 / 60 Hz	0.98	THD < 15%	>92%

FLOOD SERIES FIXTURE

FRONT VIEW

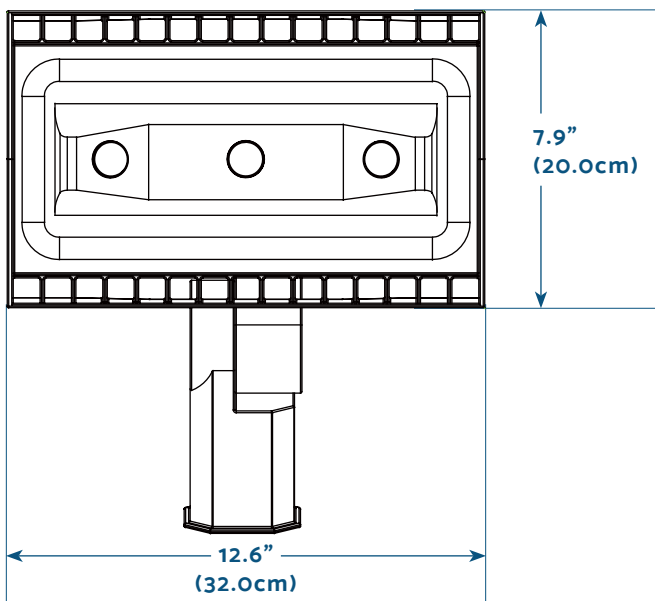

SIDE VIEW

