



EVERLAST LED EXCEL SHOE BOX 150W / 20,540LM

The EVERLAST LED EXCEL SHOE BOX 150W fixture achieves 20,540 LUMENS.

The EVERLAST LED EXCEL (ES14) SERIES offers four distribution patterns (type II, III, IV, & V) and five mount options for more strategic fixture placement and improved lighting quality in a wide variety of outdoor applications.

The EXCEL'S modern housing is rated IP66 and engineered with a streamlined design to minimize the effects of extreme outdoor conditions.

Available sensor options include on/off, bi-level, and dusk-to-dawn.

APPLICATION

Parking area and garage, street and roadway, automotive dealership, tennis court and walkway applications.

FEATURES & BENEFITS

- 137 Lumens / Watt
- 10-year Limited Warranty
- Includes 10kV surge protector

LED & OPTICAL ASSEMBLY

- Luxeon 5050 LED chips provide high flux density to enable directional and high lumen applications
- Clear polycarbonate lens assembly delivers effective beam angles and reduces glare
- Type II, III, IV, or V light distribution
- 72 CRI
- LM-79 Tests in accordance with IESNA standards

APPROVALS / LISTINGS

- DLC Premium
- UL1598
- EPA Rating: 0.64 ft2
- IP66 Rated
- Temperature rated -40° to 122°F (-40° to 50°C)
- CE / RoHS compliant
- LM80 & TM21 data available on request

MATERIALS

Inventronics LED Driver offers high performance and unprecedented quality

Extruded aluminum heat sink

Diecast aluminum fixture housing available in bronze or white

SIZE / WEIGHT (PACKAGED)

16.5" x 10.2" x 3.7" (25." x 12.0" x 7.0")

14.4 lbs. (17.5 lbs.)

MOUNTING HARDWARE

Five mount options available - three stationary (SSP, SRP, & UMB) and two adjustable (AUB & KSF).

FIXTURE

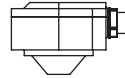

OF · BL
ON / OFF ·
BI-LEVEL
SENSOR

PC · BLPC
PHOTOCELL ·
BLANK PHOTOCELL

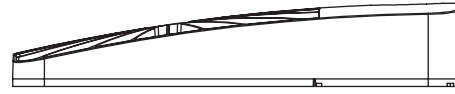

SP20
20KV SURGE
PROTECTOR
UPGRADE

TOP

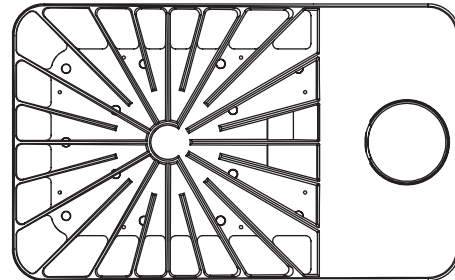

FACE

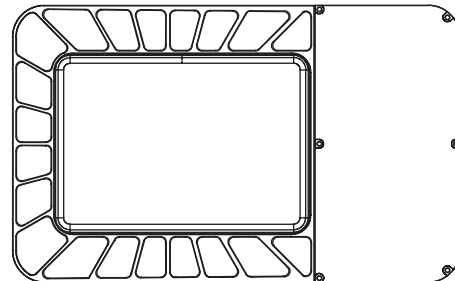

BASE

EL-ES14-	150-			
FIXTURE	WATTAGE	VOLTAGE	COLOR	DISTRIBUTION
EL-ES14- EVERLAST LED EXCEL SHOE BOX	150 WATT 20,540 LUMENS	UL 120-277V AC	50 5000K 40 4000K	II TYPE II III TYPE III IV TYPE IV V TYPE V

ACCESSORY

SENSOR

- OF ON / OFF
- BL BILEVEL
- PC NEMA PHOTOCELL
- BLPC BLANK PHOTOCELL
- 7PCR 7-PIN ANSI C136.41 PHOTOCELL RECEPTACLE

MOUNT (SEE PAGE 2)

- AUB ADJUSTABLE U BRACKET
- KSF KNUCKLE SLIP FITTER
- SRP SURFACE ROUND MOUNT
- SSP SURFACE SQUARE MOUNT
- SRP/SSP-UMB SRP or SSP + UNIVERSAL MOUNT BRACKET
- UARM UNIVERSAL ARM BRACKET

OTHER

- HSS HOUSE SIDE SHIELD
- SP20 20KV SURGE PROTECTOR UPGRADE
- W WHITE FINISH (PAGE 2)



EVERLAST LED EXCEL SHOE BOX 150W / 20,540LM

SPECS

EMITTER (LUXEON 5050) & DRIVER (INVENTRONICS)

SYSTEM WATTS (120-277V AC)	INITIAL DELIVERED LUMENS (5000K) 80CRI	NUMBER OF LEDS	TOTAL CURRENT / FIXTURE			
			120V AC	208V AC	240V AC	277V AC
150	20,540	100	1.25	0.72	0.63	0.54

INPUT

VOLTAGE RANGE	FREQUENCY RANGE	POWER FACTOR	TOTAL HARMONIC DISTORTION (DURING OUTPUT LOAD)	EFFICIENCY (230V AC / 277V AC)
100-277V AC	50 / 60 Hz	0.92	THD < 15%	>92%

DIMENSIONS

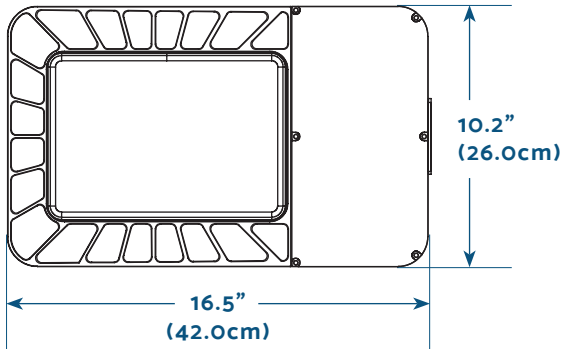
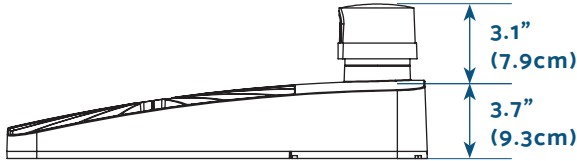

MOUNTS

ADJUSTABLE U-BRACKET (AUB)

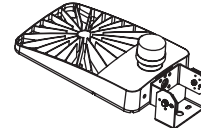

MOUNT DIMENSIONS		
LENGTH	WIDTH	HEIGHT
5.2" 13.2cm	5.3" 13.5cm	2.5" 6.4cm

KNUCKLE SLIP FITTER (KSF)

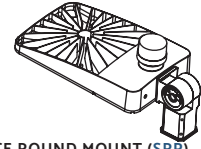

LENGTH	WIDTH	HEIGHT
7.2" 18.3cm	3.3" 8.4cm	3.3" 8.4cm

SURFACE ROUND MOUNT (SRP)

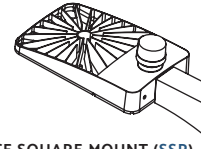

LENGTH	WIDTH	HEIGHT
6.7" 17.0cm	3.0" 7.6cm	3.9" 9.9cm

SURFACE SQUARE MOUNT (SSP)

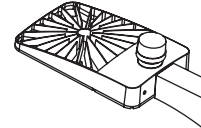

LENGTH	WIDTH	HEIGHT
6.7" 17.0cm	3.0" 7.6cm	3.9" 9.9cm

UNIVERSAL MOUNT BRACKET with SURFACE MOUNT (SRP-UMB or SSP-UMB)

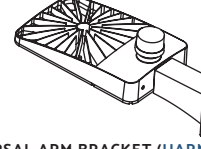

LENGTH	WIDTH	HEIGHT
8.8" 22.4cm	3.5" 9.0cm	6.1" 15.5cm

UNIVERSAL ARM BRACKET (UARM)

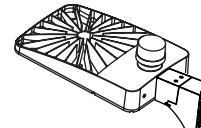

LENGTH	WIDTH	HEIGHT
6.1" 15.5cm	3.2" 8.1cm	5.8" 14.7cm

FINISH

STANDARD BRONZE FINISH

NEW WHITE FINISH



DISTRIBUTION

TYPE II
B3-U0-G3

TYPE III
B4-U0-G3

TYPE IV
B3-U0-G3

TYPE V
B5-U0-G2

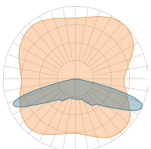
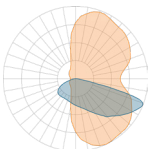
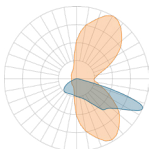
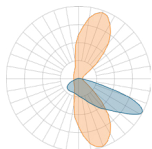

SHIELD

HOUSE SIDE SHIELD (HS)

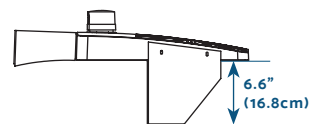

SHIELD DIMENSIONS

